

PAPER

A Coaxial Line to Post-Wall Waveguide Transition for a Cost-Effective Transformer between a RF-Device and a Planar Slot-Array Antenna in 60-GHz Band

Takafumi KAI^{†a)}, Student Member, Yusuke KATOU[†], Nonmember, Jiro HIROKAWA[†], Makoto ANDO[†], Hiroshi NAKANO^{††}, and Yasutake HIRACHI[†], Members

SUMMARY Interfaces between a coaxial structure and a post-wall waveguide are proposed as the essential components for cost-effective millimeter-wave modules. PTFE substrate is selected in terms of loss and manufacturability. The reflection and the transmission characteristics are investigated. The short-stepped and the short-taper-stepped feeding structures provide 14.7% and 13.2% bandwidths for the reflection smaller than -15 dB, respectively. The 46×40 mm² size antenna fed by the short-stepped structure in PTFE substrate gives 27.3 dBi with 58.2% efficiency at 60.0 GHz. Feeding structures in PTFE substrate fulfill electrical and manufacturing demands in millimeter-wave bands.

key words: home-link system, coaxial, post-wall waveguide, millimeter-wave band, PTFE

1. Introduction

The “home-link system” which transmits video signals with a bit-rate of several Gbps is one of the candidates for a broadband wireless system in coming ubiquitous society. For this purpose, the millimeter-wave band, especially the 60-GHz band which has the very wide unlicensed frequency range, is attractive. On the other hand, the existing millimeter-wave hardware is expensive and requires the drastic cost reduction for the use in the home-link systems.

As one of the answers to the price requirement, a planar slot-array antenna fed by a post-wall waveguide has been proposed and applied for millimeter-wave transmission systems [1]–[3]. A post-wall waveguide is fabricated by making many metalized holes in a print-circuit board. Slots are etched on one side and the post-wall planar antenna is fabricated simply and cost-effectively. The fabricated planar slot-array antenna has realized the wide range of antenna gain; 25–35 dBi and an efficiency of 40–50% has been reported so far [2], [3]. Previously, the RF power was fed to the post-wall waveguide through a WR-15 standard metal-wall waveguide via the coupling aperture cut on one of the broadwalls of the post-wall waveguide [4].

As another challenge for the cost reduction of the system, an ultra low-cost 60-GHz module has been proposed

and developed for millimeter-wave transmission systems [5]–[10]. The module is composed of some RF devices, chip-capacitors, -resistors, a planar filter and packaging. The size of the module is $26 \times 20 \times 4.5$ mm³. At 60 GHz, the transmitter- and the receiver-module can offer the output power of 10 dBm and the noise-figure of 7 dB, respectively.

With these successful developments of the components, the final step for home-link hardware system integration is to connect a 60-GHz module and a planar slot-array antenna. Unfortunately, the standard connection of the module to the antenna by using the waveguide or the coaxial-connector costs around one-third of the module and is too expensive. In addition, it is bulky and degrades the compactness of the millimeter systems; the cost-effective and slim alternatives have long been awaited.

The authors have proposed and developed cost-effective transformers to connect a 60-GHz module and a post-wall waveguide array antenna. Especially, this paper focuses upon a transition between a coaxial line and a post-wall waveguide, which is the key component in the overall proposed transformer. Figure 1 shows a bird’s-eye view of the integration with a RF device and a post-wall planar antenna. The packaged RF circuit with the microstrip line interface is mounted on the upper side of print-circuit board in which the post-wall planar antenna is formed. PTFE (Poly Tetra Fluoro Ethylen) substrate is selected for fabrication and the design takes its structural and material characteristics into account.

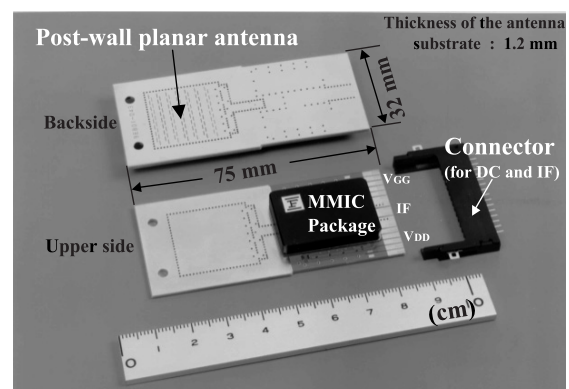

Fig. 1 A cost-effective 60 GHz module with a post-wall planar antenna.

Manuscript received September 5, 2005.

Manuscript revised November 30, 2005.

[†]The authors are with the Department of Electrical and Electronic Engineering, Tokyo Institute of Technology, Tokyo, 152-8552 Japan.

^{††}The author is with the Strategic device group, Eudyna devices Inc., Yokohama-shi, 244-0845 Japan.

a) E-mail: t-kai@antenna.ee.titech.ac.jp

DOI: 10.1093/ietcom/e89-b.5.1646

In Sect. 2, the proposed cost-effective transformer is precisely described and the purpose of this paper is declared. A variety of transformers between a coaxial line and a post-wall waveguide in PTFE substrate are proposed and studied in Sect. 3. Section 4 is devoted to discussions upon the results presented in this paper. Finally, Sect. 5 is the conclusion.

2. Proposed Cost-Effective Transformer Using a Quasi-Coaxial Structure and a Post-Wall Waveguide

Figure 2 shows a proposed cost-effective transformer between a RF device and a planar slot-array antenna using a post-wall waveguide. Figure 2(a) presents the sectional view of the transformer. The RF devices are packaged to keep their reliability and has the microstrip line as the interface. The package size is $26 \times 20 \times 4.5 \text{ mm}^3$. The output power from the RF device is fed through the connection

marked in a dotted elliptic circle in the figure. The slot antenna followed by the post-wall waveguide is formed in a print-circuit board. The one side length of the antenna is designed to be around 50 mm and the antenna can offer a gain of 25 dBi at 60 GHz. The length of the post-wall waveguide is approximately 10 mm.

Figure 2(b) specifies the connection structure between a microstrip line and a post-wall waveguide via a quasi-coaxial structure. Some techniques to connect a microstrip line and a waveguide were reported in [11]–[13]. An integrated LTCC laminated waveguide-to-microstrip line [11] and a coaxial-to-microstrip transition [12] can be candidates, but need a multilayer substrate and are a bit complicated from manufacturing and designing points of view. A transition between a microstrip line and a waveguide fabricated on a single layer dielectric substrate [13] gives promising characteristics in terms of reflection and transmission in millimeter wave bands. The microstrip line of this structure, however, is connected perpendicularly to a rectangular waveguide. The transformer is not suitable when a microstrip line-based RF circuit is placed in parallel on the backside of a waveguide planar antenna as indicated in Fig. 2. The compact and cost-effective transformer proposed in this paper can be suitable for the integration with a 60-GHz module and a planar slot-array antenna.

The proposed structure consists of two key technologies. One is the quasi-coaxial structure which is composed of several metalized posts located coaxially around an inner conductor. These posts serve as the outer conductor of the coaxial structure. The authors have already developed the transformer between a quasi-coaxial structure and a microstrip line in the previous work [14]. The through-loss was measured to be 1.2 dB at 60 GHz, where the receptacle in the V-connector was used for the measurement in place of the post-wall waveguide.

Another part of the transformer is a connection between a coaxial line and a post-wall waveguide. The post-wall waveguide and following planar antenna are simply and cost-effectively fabricated by densely arranging metalized posts in the same print-circuit board.

This paper focuses upon a transition between a coaxial line and a post-wall waveguide in order to realize the overall transformer between a microstrip line and a post-wall waveguide, in conjunction with the other transition between a quasi-coaxial structure and a microstrip line in the previous work [14]. From mass-production point of view in millimeter-wave bands, the overall characteristics of the transformer greatly depend on the shape and the dimension of the inner conductor.

PTFE substrate is chosen as print-circuit board in this paper. The substrate parameters are listed up in Table 1. A PTFE is low loss material and a large sized antenna of gain up to 35 dBi can be realized in the substrate. Manufacturing such as suspended via-holes and its metallization is difficult because the substrate is fiberglass-reinforced and mechanically strong. Various types of transitions between a coaxial line and a post-wall waveguide in PTFE substrate

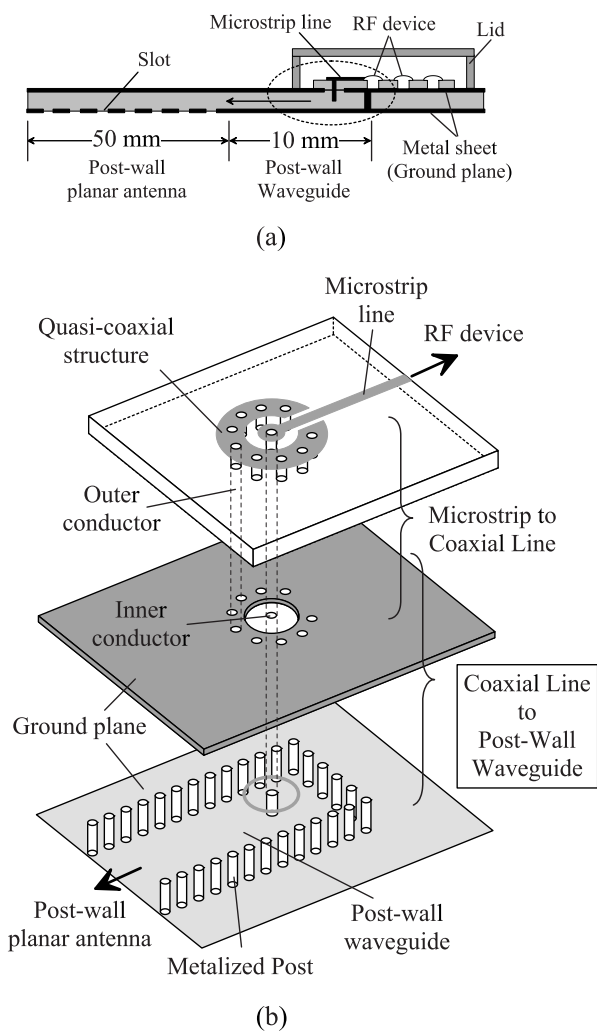

Fig. 2 A proposed cost-effective transformer between a RF device and a planar slot-array antenna using a post-wall waveguide. (a) The sectional view of the transformer. (b) The precise connection structure between a microstrip line and a post-wall waveguide.

Table 1 Parameters of PTFE substrate.

Thickness	1.2 mm
Permittivity	2.17
$\tan \delta$	0.00085
Post Diameter	0.5 mm
Post Spacing	1.0 mm
Waveguide Width	3.08 mm

are proposed and discussed in Sect. 3. The manufacturing reliability, the frequency characteristics of the reflection and the transmission loss are investigated and verified experimentally in 60-GHz band.

3. Transitions between a Coaxial Line and a Post-Wall Waveguide in PTFE Substrate

The literatures [15]–[17] reported several types of transitions between a coaxial line and a rectangular waveguide and their discussions concentrated on the analysis and the design of the transformers. The reliability in manufacturing and frequency characteristics of transformers are important especially in the millimeter-wave bands but were not discussed sufficiently. This paper investigates four kinds of transformers between a coaxial-line and a post-wall waveguide in PTFE substrate, as shown in Fig. 3. Structures (c) and (d) are proposed here while (a) and (b) were developed before in [15]–[17]. Post-walls of waveguides are replaced with a metal-wall waveguide with equal guided wavelength in the design [1].

Feeding structures in Fig. 3 are described below. The structure (a) is an open-ended structure [15], [17]. The inner conductor is suspended in the middle of a dielectric substrate. The input impedance is controlled in a wide range by changing the insertion length h in a substrate and the position of the short wall s . This structure however is not suitable for a PTFE substrate since the reflection characteristics is sensitive for the insertion length h while the control of the length by metallization of a blind alley is very difficult.

Figure 3(b) presents the conventional short-ended structure [16]. The inner conductor penetrates a PTFE substrate and then metallization of the inner conductor is easy. However, the inner conductor excessively perturbs the electric field in the waveguide and the input impedance is much larger than 50Ω . Reflection suppression over a broad bandwidth would be difficult though the additional posts may be used to suppress the reflection in only a narrow band.

Another type of transformer with a short-stepped structure, which is proposed in this paper, is shown in Fig. 3(c) [18]. The inner conductor in a PTFE substrate has a stepped structure at the end. The stepped structure lowers the input impedance and wide band matching to a coaxial line would be expected. Precise manufacturing and metallization of the inner conductor are possible in a PTFE substrate since the inner conductor penetrates the substrate. Figure 3(d) shows an alternative realization of Fig. 3(c) [18]. The taper-step structure is installed at the end of the inner conductor. It is expected that the metalizing-liquid flows into the end of the

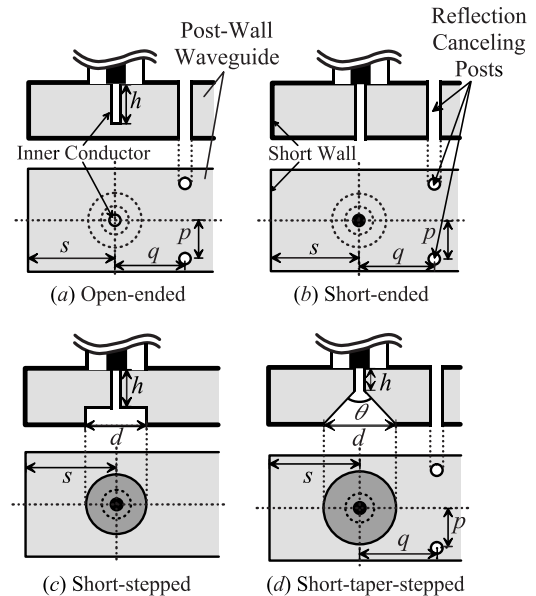

Fig. 3 Transformers between coaxial line and post-wall waveguide in PTFE substrate (post-walls are replaced with conducting walls at the equivalent position in the analysis).

inner conductor more easily.

3.1 Design

The transformers are designed at 60 GHz to suppress the reflection over a wide frequency range for given dimensions of post-wall waveguides. In the design, a post-wall waveguide is replaced with a metal-wall waveguide to have equal guided wavelength [1]. Table 1 indicates the parameters of the PTFE substrate. The diameter of the inner conductor is chosen to be 0.3 mm. An FEM-based electromagnetic field simulator “Ansoft HFSS” is utilized for the design.

Initial parameters are introduced for each structure as described below. A cylindrical metallic post that extends into the waveguide is a reactive element in waveguide matching. In a short-ended structure, when h is equal to the waveguide height, the axial current induced by the dominant TE_{10} mode is constant along the post surface so that the inductance is too large. To weaken the EM coupling of the inner field in the waveguide, the short-ended post would be placed for the matching at the position of around $0.5 \lambda_g$ (λ_g is guide wavelength in the waveguide) from the shorting wall.

On the other hand, the open-ended structure equivalently works as a series circuit of inductance and capacitance. The metallic post itself has inductance and the capacitance generates between the open-end of the post and the facing waveguide wall. The input impedance can be controlled by changing the length of the inner conductor h and series resonance is realized when h is equal to about $0.25 \lambda_\epsilon (= \lambda_0 / \sqrt{\epsilon_r})$. The distance between the inner conductor and the shorting wall would be approximately $0.25 \lambda_g$ in order to obtain the strong coupling with the inner field of

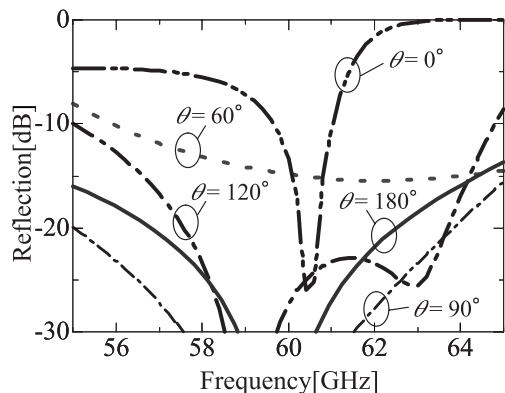

Fig. 4 Calculated results of reflection characteristics for various angles of inner conductors in PTFE substrate.

the waveguide. The taper-stepped structures in (c) and (d) are used for impedance reduction so that the position of the shorting wall s would be around $0.25 \lambda_g$ as well. Additional reflection canceling posts, which fully penetrate the waveguide, would be installed to assist the suppression of the reflection if required. These posts are located around $0.25 \lambda_g$ and $0.50 \lambda_g$ from the inner conductor in the open-ended and short-ended structures, respectively.

Based upon above initial parameters, the insertion length h (in (a), (c) and (d)), the angle of gradient θ (in (d)), the step width d (in (c)), the short position s and the reflection canceling posts position p , q (in (a), (b) and (d)) are determined by iteration in a few turns. Let the shorting posts position s be measured from the center of the inner conductor to that of the shorting posts.

Figure 4 shows the calculated frequency characteristics of the reflection for various angles of the inner conductor, where the transformers are designed to minimize the reflection. The structures of $\theta = 90^\circ$, 120° and 180° give bandwidth wider than 10% with respect to the reflection below -15 dB. Even if not reflection canceling posts, a wide bandwidth for reflection suppression is obtained in case of $\theta = 180^\circ$. The taper-stepped structures decrease the input impedance and match to a coaxial line over a wide frequency bandwidth. On the other hand, when the declining angle θ is 0° and 60° , the bandwidths become narrow, 2.0% and 5.9%, respectively. The size of the taper-stepped structure is small and the input impedance of the structure does not decrease so that the suppression of the reflection is difficult in the sufficient broad bandwidth.

Table 2 summarizes the parameters of structure (a)–(d) after fine optimization. The structures of $\theta = 180^\circ$ and 120° are applied as short-stepped (c) and short-taper-stepped structures (d), respectively in this paper. The final parameters are almost close to the initial ones mentioned above, or the values plus around $0.5 \lambda_g$. The parameter p is around $0.35 \lambda_g$ irrespective of the structure.

Figure 5 summarizes the calculated frequency characteristics of the reflection for the transitions between a coaxial line and a post-wall waveguide. The reflection

Table 2 Determined parameters of transitions.

	s mm (λ_g)	h mm (λ_g)	p mm (λ_g)	q mm (λ_g)
Open-ended	2.89 (0.70)	0.90 (0.27)	1.20 (0.35)	1.50 (0.37)
Short-ended	1.99 (0.49)	–	1.20 (0.35)	1.80 (0.44)
Short-stepped ($d = 1.4$ mm)	1.25 (0.31)	0.70 (0.21)	–	–
Short-taper-stepped ($d = 2.8$ mm $\theta = 120^\circ$)	3.39 (0.83)	0.39 (0.11)	1.20 (0.35)	3.40 (0.84)

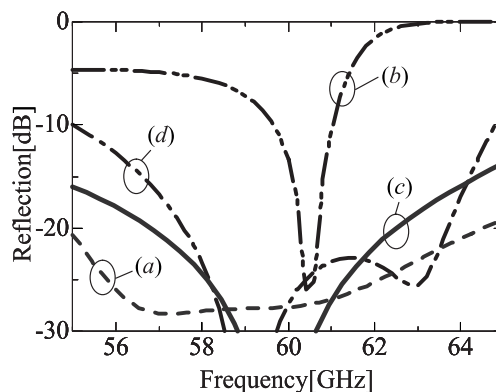

Fig. 5 Calculated results of reflection characteristics of transitions between a coaxial line and a post-wall waveguide in PTFE substrate.

of structure (a) has a very wide frequency range between 55 GHz and 65 GHz with the reflection below -20 dB. In the short-ended structure (b), the bandwidth less than -15 dB is not wide, 2.0%, as expected. On the contrary, the short-stepped (c) and the short-taper-stepped structures (d) give wide bandwidths of 16.7% and 12.8%, respectively, where the reflections are below -15 dB. The structure (c) and (d) are comparable to the open-ended structure (a) in terms of the bandwidth of the reflection.

3.2 Fabrication

Figure 6 includes the cross-sectional photos of the fabricated structures (a)–(c). In the structure (a), the metalizing does not reach into the end of the inserted inner conductor. The metalizing-liquid tends to be reluctant to creep in a narrow gap. This tendency causes a serious difference between analysis and measurement. On the other hand, the surface of the inner conductor in (b) is metalized smoothly. The stepped structure in (c) is grinded by using a particular T-type drill. The surface and the metallization are almost smooth while the roughness of the metallization around the discontinuity of the stepped structure is observed. Figure 6(d) shows a photo from above. The metalizing has been successfully done over the whole inner conductor. The taper structure is smooth and is well suited to be metalized. It would contribute to the robustness against fabrication error.

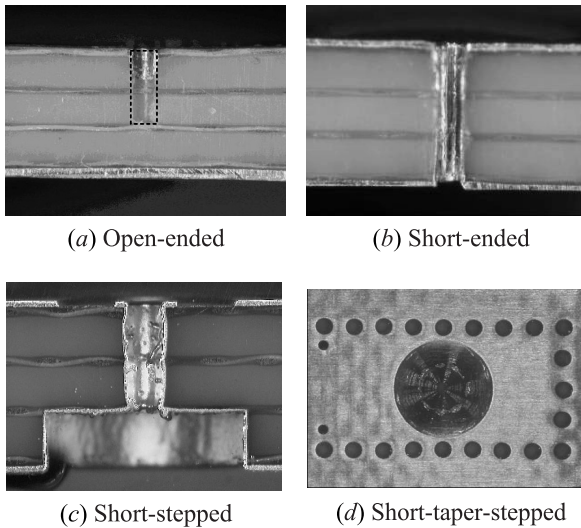

Fig. 6 Photos of fabricated transitions between a coaxial line and a post-wall waveguide in PTFE substrate.

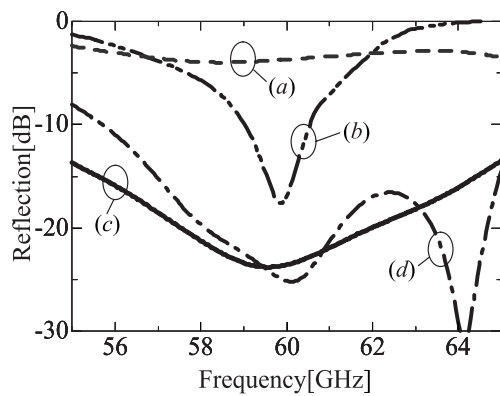

Fig. 7 Experimental results of reflection characteristics of transitions between a coaxial line and a post-wall waveguide in PTFE substrate.

3.3 Measured Frequency Characteristics of the Reflection

In following measurements, the receptacle in the V-connector is installed in place of the post-wall waveguide. Reflection coefficients of the transitions themselves are extracted by using the time-gate function of the vector network analyzer. Figure 7 shows the measured frequency characteristics of the reflection for the structure (a)–(d). For the structure (a), a serious increase of reflection is observed in the measurement; the reflection is larger than approximately -3 dB although the broad band suppression of the reflection is predicted in calculation. The short-ended structure (b) has a very narrow bandwidth, 1.1%, for a reflection less than -15 dB. The frequency range below -15 dB of the structure (c) is as wide as 55.6–64.4 GHz (14.7%) while the calculation predicts well the measured bandwidth. The structure (d) also provides a wide bandwidth, 7.9 GHz (13.2%). The discrepancy in (b)–(d) between analysis and measurement is acceptable so that accurate manufacturing is confirmed.

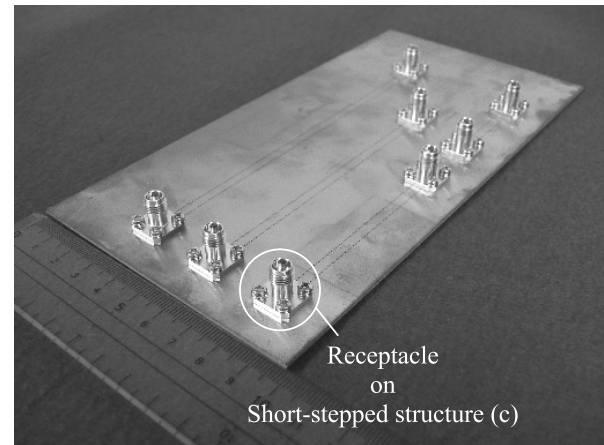

Fig. 8 Experimental model for transmission characteristics of short-stepped structure (c) in PTFE substrate.

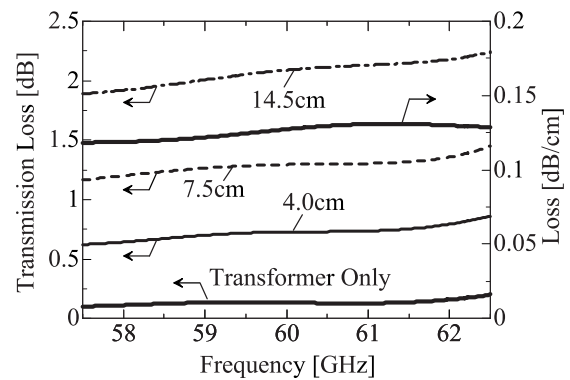

Fig. 9 Measured transmission characteristics of short-stepped structure (c) in PTFE substrate.

The structure (c) and (d) fulfill the required bandwidth of 7.0 GHz for a reflection less than -15 dB and can be candidates for millimeter-wave band wireless systems.

3.4 Transmission Characteristics of Short-Stepped Structure (c)

We fabricated various lengths of straight post-wall waveguides. Each post-wall waveguide is terminated by a few posts at the both ends and the transformers with the short-stepped structure (c) are installed as the ports for back-to-back measurement of the transmission coefficients. Receptacles are installed on the structure (c) at both ports in the measurements as shown in Fig. 8. From the measured transmission characteristics as a function of the waveguide length, the insertion loss of the transformer and the transmission loss per centimeter are identified. Figure 9 shows the frequency dependence of the measured transmission loss of each waveguide, the loss per centimeter and the insertion loss for the structure (c). The thin lines show the transmission loss after eliminating the reflection loss of the input aperture in order to compensate the reflection loss in each waveguide. The transmission loss increases as the wave-

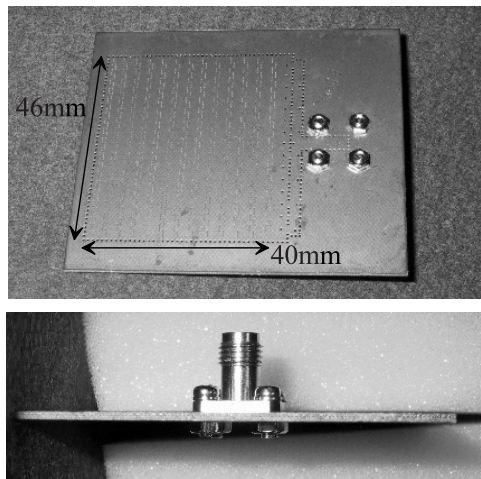

Fig. 10 Coaxial line feed post-wall waveguide planar slot array antenna.

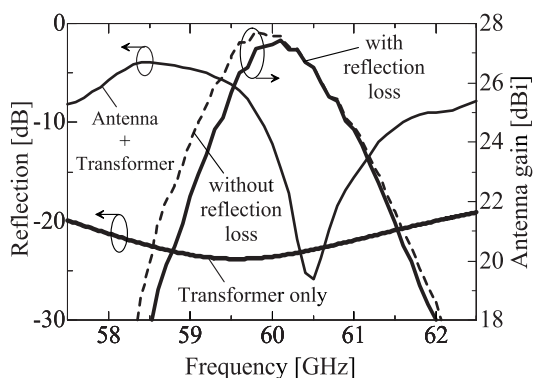

Fig. 11 The reflection and gain characteristics of the antenna fed by the short-stepped structure (c).

guide becomes longer. The loss of the post-wall waveguide is around 0.13 dB/cm and the insertion loss of the transformer only is about 0.13 dB at 60.0 GHz. Assuming 1 cm as the typical size of the connection between the transformer and antenna, we can estimate the total connector loss of about 0.26 dB for the structure (c).

3.5 Overall Reflection and Loss of a Short-Stepped Structure (c) with a Prototype High Gain Antenna

Overall characteristics of the transformer including a large sized high gain antenna in the PTFE substrate is demonstrated. We manufacture a post-wall waveguide planar antenna [1]–[3] fed by the short-step structure (c) as shown in Fig. 10. A post-wall feed waveguide in the antenna has several coupling windows to excite a TEM wave in a parallel plate waveguide, where slot pairs are arrayed and designed to obtain a uniform aperture distribution. The design of this feed waveguide is not mature and is still narrow band [2], [3]. Figure 11 shows the frequency dependence of the overall reflection at the input port and the gain of the antenna. The reflection is around -12.2 dB (6.0% loss) at 60.0 GHz. The peak of the measured antenna gain

Table 3 Bandwidth for reflection less than -15 dB and tolerance to fabrication error.

	Analysis	Experiment	Tolerance
Open-ended	More than 15[%]	×	Poor
Short-ended	2.0[%]	1.1[%]	Good
Short-stepped	More than 15[%]	14.7[%]	Fair
Short-taper-stepped	12.8[%]	13.2[%]	Fair

is 27.3 dBi with 58.2% efficiency at 60.0 GHz for the aperture size 40×46 mm². The frequency range in which the gain is larger than 25 dBi is 59.4–60.9 GHz (2.5%). The gain loss due to the reflection is about 0.3 dB ($100\% - 6\% = 94\%$) around 60 GHz but is much larger otherwise. In order to identify the gain loss due to these, the thin dotted line in Fig. 11 indicates the antenna gain if not for the reflection loss. This result reveals that the antenna with the low loss transformer would have the potential for excellent efficiency up to 60%, and 3.0% bandwidth larger than 25 dBi. The reflection characteristics of the short-stepped transformer only is also included in Fig. 11. This specific array of the antenna is too narrow-band to fully utilize the wide band characteristics of the transformer discussed here.

4. Discussions

Table 3 summarizes the bandwidths of the reflection for analysis, experiment and the tolerance against fabrication error upon the transformers in PTFE substrate. The bandwidths are discussed for the reflection less than -15 dB. The analysis results show broadband frequency characteristics except for the short-ended structure, while the serious degradations are observed in open-ended structure in the measurement since the fabrication of the inner conductor is crucial. Short-ended, short-stepped and short-taper-stepped structures have the acceptable agreement with the analysis results. These structures are well suited to metalizing the inner conductor in PTFE substrate. The structures (b), (c) and (d) that penetrate the dielectric substrate are more advantageous than the structure (a) in terms of process yield of the inner conductor as well as fabrication cost. In particular, short-stepped and short-taper-stepped structures give enough measured bandwidths, 14.7% and 13.2%, respectively.

Overall characteristics of the transformer (c) with the post-wall waveguide antenna are discussed and demonstrated experimentally. The 46×40 mm² size antenna fed by the short-stepped structure in PTFE substrate gives 27.3 dBi with 58.2% efficiency at 60.0 GHz. So, the low loss characteristics are confirmed but the bandwidth is narrow mainly due to the immature design of the feeding waveguide in the array. Above results support a fine prospect for realizing high efficiency 60 GHz modules with high antenna gain.

5. Conclusion

The authors have proposed a millimeter-wave band interface to a post-wall waveguide through a coaxial structure. The fabrication tolerance is also discussed for PTFE substrate. Four kinds of the structures as shown in Fig. 3 are proposed and discussed. The short-stepped (c) and the short-taper-stepped (d) structures give 14.7% and 13.2% bandwidths for a reflection smaller than -15 dB, respectively. We fabricated a 40×46 mm² sized post-wall planar antenna with the structure (c). The peak of the measured antenna gain is 27.3 dBi with 58.2% efficiency at 60.0 GHz, though the bandwidth is narrowed due to the imperfect reflection characteristics of the array. Post-wall antenna design with better and wideband reflection characteristics is left for future study. Feeding structures in PTFE substrate fulfill electrical and manufacturing demands in millimeter-wave bands.

Acknowledgments

This work has been supported in part by the Key Technology Research Promotion Program in National Institute of Information and Communications Technology.

References

- [1] J. Hirokawa and M. Ando, "Single-layer feed waveguide consisting of posts for plane TEM wave excitation in parallel plates," *IEEE Trans. Antennas Propag.*, vol.46, no.5, pp.625–630, May 1998.
- [2] J. Hirokawa and M. Ando, "Efficiency of 76-GHz post-wall waveguide-fed parallel-plate slot arrays," *IEEE Trans. Antennas Propag.*, vol.48, no.11, pp.1742–1745, Nov. 2000.
- [3] J. Hirokawa and M. Ando, "Sidelobe suppression in 76-GHz post-wall waveguide-fed parallel-plate slot arrays," *IEEE Trans. Antennas Propag.*, vol.48, no.11, pp.1727–1732, Nov. 2000.
- [4] T. Kai, J. Hirokawa, and M. Ando, "Feed through an aperture to a post-wall waveguide with step structure," *IEICE Trans. Commun.*, vol.E88-B, no.3, pp.1298–1302, March 2005.
- [5] Y. Hirachi, Y. Aoki, T. Yamamoto, J. Ishibashi, and A. Kato, "A cost-effective RF-module for millimeter-wave systems," *1998 Asia-Pacific Microwave Conference Proceeding*, vol.1, TU1A-1, pp.53–56, Dec. 1998.
- [6] Y. Hirachi, H. Nakano, and A. Kato, "A cost-effective RF-module with built-in patch antenna for millimeter-wave systems," *29th European Microwave Conference, Conference Proceeding*, vol.3, pp.347–350, Munich, Oct. 1999.
- [7] Y. Hirachi, H. Nakano, and A. Kato, "A cost-effective receiver-module with built-in patch antenna for millimeter-wave wireless systems," *GAAS 2000, Conference Proceeding*, pp.284–287, Paris, Oct. 2000.
- [8] H. Nakano, H. Yamawaki, and Y. Hirachi, "Cost-effective 60-GHz modules with phase-noise of -110 dBc/Hz at 100 kHz offset using novel self-heterodyne scheme," *GAAS 2001, Conference Proceeding*, pp.77–80, London, Oct. 2001.
- [9] H. Nakano, H. Yamawaki, and Y. Hirachi, "Cost-effective 60-GHz module with novel self-heterodyne scheme for gigabit home-link systems," *2002 Asia-Pacific Microwave Conference Proceeding*, vol.3, FR1A-1, pp.1377–1380, Nov. 2002.
- [10] H. Nakano, K. Kosemura, T. Hamada, Y. Hirachi, J. Hirokawa, and M. Ando, "Cost-effective 60-GHz module with a post-wall planar antenna for gigabit home-link systems," *6th European Microwave on Wireless Technology Conference, Proceeding*, pp.25–28, Munich, Oct. 2003.
- [11] Y. Huang, K.-L. Wu, and M. Ehlert, "An integrated LTCC laminated waveguide-to-microstrip line T-junction," *IEEE Microw. Wireless Components Letters*, vol.13, no.8, pp.338–339, Aug. 2003.
- [12] S.A. Wartenberg and Q.H. Liu, "A coaxial-to-microstrip transition for multilayer substrates," *IEEE Trans. Microw. Theory Tech.*, vol.52, no.2, pp.584–588, Feb. 2004.
- [13] H. Iizuka, T. Watanabe, K. Sato, and K. Nishikawa, "Millimeter-wave microstrip line to waveguide transition fabricated on a single layer dielectric substrate," *IEICE Trans. Commun.*, vol.E85-B, no.6, pp.1169–1177, June 2002.
- [14] U. Azuma, J. Hirokawa, M. Ando, H. Nakano, and Y. Hirachi, "Low loss connection between millimeter-wave RF planar circuits and radial waveguide through coaxial structure," *IEICE Technical Report*, A-P02-121, Jan. 2003.
- [15] A.G. Williamson, "Coaxially fed hollow probe in a rectangular waveguide," *Proc. Inst. Elec. Eng.*, vol.132, Part H, no.5, pp.273–285, Aug. 1985.
- [16] A.G. Williamson, "Analysis and modelling of a coaxial-line/rectangular-waveguide junction," *Proc. Inst. Elec. Eng.*, vol.129, Part H, no.5, pp.262–270, Oct. 1982.
- [17] R.B. Keam and A.G. Williamson, "Broadband design of coaxial line/rectangular waveguide probe transition," *IEE Proc. Microw. Antennas Propag.*, vol.141, no.1, pp.53–58, Feb. 1994.
- [18] Y. Kato, J. Hirokawa, M. Ando, H. Nakano, and Y. Hirachi, "Coaxial-line feed for millimeter-wave post-wall waveguides," *IEICE Technical Report*, A-P03-259, Jan. 2004.



Takafumi Kai was born in Miyazaki, Japan, on July 24, 1978. He received the B.S., M.S. and D.E. degrees in electrical and electric engineering from Tokyo Institute of Technology, Tokyo, Japan in 2001, 2003 and 2006, respectively. His main interests have been feeding circuits and planar array antennas using a post-wall waveguide.



Yusuke Katou was born in Tokyo, Japan, on October 2, 1979. He received the B.S. and M.S. degrees in electrical and electric engineering from Tokyo Institute of Technology, Tokyo, Japan in 2002 and 2004, respectively. He is currently with Fujitsu Laboratories Ltd., Kawasaki, Japan, and engaged in development of car collision avoidance radar systems.

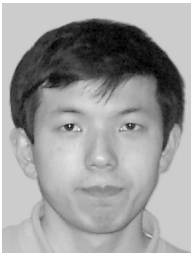

Jiro Hirokawa was born in Tokyo, Japan, on May 8, 1965. He received the B.S., M.S. and D.E. degrees in electrical and electronic engineering from Tokyo Institute of Technology (Tokyo Tech), Tokyo, Japan in 1988, 1990 and 1994, respectively. He was a Research Associate from 1990 to 1996, and is currently an Associate Professor at Tokyo Tech. From 1994 to 1995, he was with the antenna group of Chalmers University of Technology, Gothenburg, Sweden, as a Postdoctoral Fellow. His re-

search area has been in analyses of slotted waveguide array antennas. He received an IEEE AP-S Tokyo Chapter Young Engineer Award in 1991, a Young Engineer Award from IEICE in 1996, a Tokyo Tech Award for Challenging Research in 2003 and a Young Scientist Award from the Minister of Education, Cultures, Sports, Science and Technology in Japan in 2005. He is a Senior Member of IEEE.



Makoto Ando was born in Hokkaido, Japan, on February 16, 1952. He received the B.S., M.S. and D.E. degrees in electrical engineering from Tokyo Institute of Technology, Tokyo, Japan in 1974, 1976 and 1979, respectively. From 1979 to 1983, he worked at Yokosuka Electrical Communication Laboratory, NTT, and was engaged in development of antennas for satellite communication. He was a Research Associate at Tokyo Institute of Technology from 1983 to 1985, and is currently a

Professor. His main interests have been high frequency diffraction theory such as Physical Optics and Geometrical Theory of Diffraction. His research also covers the design of reflector antennas and waveguide planar arrays for DBS and VSAT. Latest interest includes the design of high gain millimeter-wave antennas. He received the Young Engineers Award of IECE Japan in 1981, the Achievement Award and the Paper Award from IEICE Japan in 1993. He also received the 5th Telecom Systems Award in 1990 and the 8th Inoue Prize for Science in 1992. He serves as the Chair of Commission B of URSI from 2002 to 2005 and the member of Administrative Committee of IEEE Antennas and Propagation Society 2004–2006. He is a Fellow, IEEE.



Hiroshi Nakano was born in Nagano, Japan, on March 13, 1961. He received the B.S. and M.S. degrees in electrical and electric engineering from Shibaura Institute of Technology, Tokyo, Japan in 1984 and 1986, respectively. From 1986 to 1998, he was with the Olympus Optical Co., Ltd. as the engineer of the memory device using ferroelectric material. From 1998 to 2004, he worked at Fujitsu Quantum Devices Ltd. and was engaged in development of high frequency RF transmitter and receiver modules. He is currently

with Eudyna Devices Inc. and engaged in development of high frequency MMIC and RF module.



Yasutake Hirachi was born in Tokyo, Japan, on Dec. 24, 1944. He received the B.S. and M.S. degrees in electrical engineering from Tokyo University of Agriculture and Technology, Tokyo, Japan in 1968 and 1970, respectively. In 1979 he received the Ph.D. degree in electrical engineering from Tokyo Institute of Technology, Tokyo. From 1970 to 1971 he was a Research Associate at Tokyo Institute of Technology. In 1971 he joined Fujitsu Laboratories Ltd., since then he had been engaged in the re-

search, development and business for microwave- and millimeter-wave IMPATT diodes, GaAs FET's and HEMT's. From 1991 to 1998, he had been a manager in the research and development division of Olympus Optical Co., Ltd.. In 1998 he joined Fujitsu Quantum Devices Ltd. and was managing the development and business of MMIC's and millimeter-wave subsystems. From 2000 to 2005 he was a visiting professor in Tokyo Institute of Technology. In 2003 he was supported by the Key Technology Research Promotion Program in National Institute of Information and Communications Technology. He is currently a Research Fellow of Tokyo Institute of Technology. He received the 1978 Watanabe memorial award for the GaAs hi-lo IMPATT diodes and the 1989 Ichimura Award for the outstanding contribution to the practical use of HEMT's. He published a technical book entitled "GaAs Field-Effect Transistors" from the Institute of Electrical, Information and Communication Engineers of Japan and an easier technical book entitled "Compound Semiconductor Devices supporting the Internet World" from the Kogyo Chosakai Publishing Co., Ltd.. He is an auditor of 2006 Asia-Pacific Microwave Conference Committee. Dr. Hirachi is a Member of IEEE MTT society.